

N

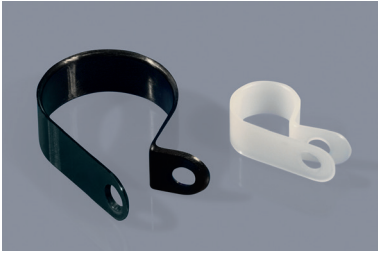

Kabelschellen aus Kunststoff
Plastic cable clamps

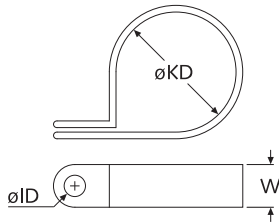

Standard-Material:

PA UL-94 V2 natur
-40°C bis +75°C

PA UL-94 V2 schwarz UV
-40°C bis +75°C

Durchschlagsfestigkeit: 12 kV/mm

Material auf Anfrage:

PP natur

PP schwarz

Art.-Nr.	Artikel-Bez.	KD	ID	W	Farbe	Art.-Nr.	Artikel-Bez.	KD	ID	W	Farbe
natur		∅	∅			schwarz		∅	∅		
34062	N-00MM-01-N	0,8	2,4	4,0	 	-	-	-	-	-	
00860	N-01-01-N	1,6	3,2	9,5	 	25628*	N-01-01-S*	1,6	3,2	9,5	
34064	N-01.5-01-N	2,4	2,4	4,0	 	-	-	-	-	-	
25107	N-02MM-01-N	3,2	2,4	4,0	 	-	-	-	-	-	
25626	N-02S-01-N	3,2	3,2	9,5	 	-	-	-	-	-	
00861	N-02-01-N	3,2	4,3	9,5	 	25629	N-02-01-S	3,2	4,3	9,5	
16248	N-02M-01-N	3,2	5,2	9,5	 	24125	N-02M-01-S	3,2	5,2	9,5	
01200	N-02B-01-N	3,2	5,2	12,7	 	24135	N-02B-01-S	3,2	5,2	12,7	
34066	N-02.5-01-N	4,0	2,4	4,0	 	-	-	-	-	-	
26965	N-03MM-01-N	4,8	2,4	4,0	 	-	-	-	-	-	
00862	N-03-01-N	4,8	4,3	9,5	 	10170	N-03-01-S	4,8	4,3	9,5	
16249	N-03M-01-N	4,8	5,2	9,5	 	24126	N-03M-01-S	4,8	5,2	9,5	
01201	N-03B-01-N	4,8	5,2	12,7	 	24136	N-03B-01-S	4,8	5,2	12,7	
34068	N-04MM-01-N	6,4	3,3	7,1	 	-	-	-	-	-	
00863	N-04-01-N	6,4	4,3	9,5	 	25630	N-04-01-S	6,4	4,3	9,5	
16250	N-04M-01-N	6,4	5,2	9,5	 	24127	N-04M-01-S	6,4	5,2	9,5	
01202	N-04B-01-N	6,4	5,2	12,7	 	19942	N-04B-01-S	6,4	5,2	12,7	
00864	N-05-01-N	8,0	4,3	9,5	 	25631	N-05-01-S	8,0	4,3	9,5	
16251	N-05M-01-N	7,9	5,2	9,5	 	24128	N-05M-01-S	7,9	5,2	9,5	
01203	N-05B-01-N	7,9	5,2	12,7	 	24138	N-05B-01-S	7,9	5,2	12,7	
00865	N-06-01-N	9,5	4,3	9,5	 	25632	N-06-01-S	9,5	4,3	9,5	
16252	N-06M-01-N	9,5	5,2	9,5	 	24129	N-06M-01-S	9,5	5,2	9,5	
01204	N-06B-01-N	9,5	5,2	12,7	 	24139	N-06B-01-S	9,5	5,2	12,7	
00866	N-07-01-N	11,1	4,3	9,5	 	25633	N-07-01-S	11,1	4,3	9,5	
16253	N-07M-01-N	11,1	5,2	9,5	 	24130	N-07M-01-S	11,1	5,2	9,5	
01205	N-07B-01-N	11,1	5,2	12,7	 	24140	N-07B-01-S	11,1	5,2	12,7	
00867	N-08-01-N	12,7	4,3	9,5	 	25634	N-08-01-S	12,7	4,3	9,5	
16254	N-08M-01-N	12,7	5,2	9,5	 	24131	N-08M-01-S	12,7	5,2	9,5	
01206	N-08B-01-N	12,7	5,2	12,7	 	24133	N-08B-01-S	12,7	5,2	12,7	
01185	N-09B-01-N	14,3	5,2	12,7	 	24141	N-09B-01-S	14,3	5,2	12,7	
16255	N-10M-01-N	15,9	5,2	9,5	 	-	-	-	-	-	
41660	N-10H-01-N	15,9	4,2	10,0	 	-	-	-	-	-	
01207	N-10B-01-N	15,9	5,2	12,7	 	24134	N-10B-01-S	15,9	5,2	12,7	
01208	N-11B-01-N	17,5	5,2	12,7	 	24142	N-11B-01-S	17,5	5,2	12,7	
01209	N-12B-01-N	19,1	5,5	12,7	 	24143	N-12B-01-S	19,1	5,5	12,7	
23974	N-13B-01-N	20,6	5,2	12,7	 	24150	N-13B-01-S	20,6	5,2	12,7	
01210	N-14B-01-N	22,2	5,2	12,7	 	24144	N-14B-01-S	22,2	5,2	12,7	
01211	N-16B-01-N	25,4	5,2	12,7	 	24145	N-16B-01-S	25,4	5,2	12,7	
01212	N-18B-01-N	28,6	5,2	12,7	 	24146	N-18B-01-S	28,6	5,2	12,7	
NEW 52485	N-20B-01-N	30,1	5,2	12,7	 	52486	N-20B-01-S	30,1	5,2	12,7	
NEW 52487	N-22B-01-N	31,8	5,2	12,7	 	52488	N-22B-01-S	31,8	5,2	12,7	
NEW 52489	N-26B-01-N	34,9	5,2	12,7	 	52490	N-26B-01-S	34,9	5,2	12,7	
NEW 45983	N-28B-01-N	38,1	5,2	12,7	 	45984	N-28B-01-S	38,1	5,2	12,7	

*nicht UV-beständig · weitere Abmessungen a. A. · Unit: mm · MOQ siehe Website

■ NS



Kabelschellen aus Kunststoff
Plastic cable clamps

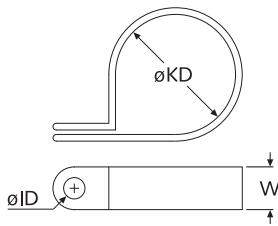

Art.-Nr.		Artikel-Bez.	KD ø	ID ø	W
schwarz	grau				
15431	47839	NS-03-...	3,0	3,0	7,0
15432	47840	NS-05-...	5,0	3,0	7,0
15433	47841	NS-06-...	6,0	3,0	7,0
15434	47842	NS-07-...	7,0	5,0	12,0
15435	47843	NS-08-...	8,0	5,0	12,0
15436	47844	NS-09-...	9,0	5,0	12,0
15437	47845	NS-10-...	10,0	5,0	12,0
15438	47846	NS-12-...	12,0	5,0	12,0
15439	47847	NS-14-...	14,0	5,0	12,0
15440	47848	NS-16-...	16,0	5,0	12,0
15441	47849	NS-18-...	18,0	5,0	12,0

Art.-Nr.		Artikel-Bez.	KD ø	ID ø	W
schwarz	grau				
15442	47850	NS-20-...	20,0	5,0	12,0
15443	47851	NS-22-...	22,0	5,0	12,0
15444	47852	NS-24-...	24,0	5,0	12,0
15445	47853	NS-26-...	26,0	5,0	12,0
15446	47854	NS-28-...	28,0	5,0	12,0
15447	47855	NS-30-...	30,0	5,0	12,0
15448	47856	NS-34-...	34,0	5,0	12,0
15449	47857	NS-38-...	38,0	5,0	16,0
15450	47858	NS-42-...	42,0	5,0	16,0
15451	47859	NS-46-...	46,0	5,0	16,0
15452	47860	NS-50-...	50,0	5,0	16,0

Unit: mm · MOQ 100x

Standard-Material:

PA - ■ schwarz -40°C bis +130°C (Durchschlagsfestigkeit: 60 kV/mm)
H-PVC UL-94 V-0 ■ grau -20°C bis +65°C (Durchschlagsfestigkeit: 35 kV/mm)

Info: Alterungs-, korrosions-, ozon- und UV-beständig

■ AL



Kabelschellen aus Aluminium
Aluminium cable clamps

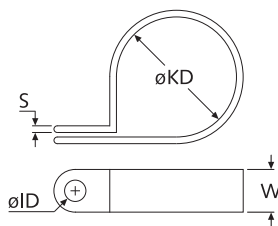

Art.-Nr.	Artikel-Bez.	KD ø	ID ø	W	S
00926	AL-02	3,2	5,2	9,5	0,8
00927	AL-03	4,8	5,2	9,5	0,8
02020	AL-04	6,4	4,6	9,5	0,8
02021	AL-05	7,9	5,2	9,5	0,8
02099	AL-06	9,5	5,2	9,5	0,8
02100	AL-07	11,1	5,2	9,5	0,8
02101	AL-08	12,7	5,2	9,5	0,8
02102	AL-09	14,3	5,2	9,5	0,8

Art.-Nr.	Artikel-Bez.	KD ø	ID ø	W	S
02103	AL-10	15,9	5,2	9,5	0,8
02104	AL-11	17,5	5,2	12,7	1,6
02105	AL-12	19,1	5,2	12,7	1,6
02106	AL-14	22,2	5,2	12,7	1,6
02107	AL-15	23,8	5,2	12,7	1,6
02108	AL-16	25,4	5,2	12,7	1,6
02109	AL-18	28,6	5,2	12,7	1,6
29101	AL-20	31,8	5,2	12,7	1,6

Unit: mm · MOQ 100x

Standard-Material: Aluminium, blank

Material auf Anfrage: Aluminium, blank, mit schwarzem PVC-Überzug

MWS + MWSEA + MWSET + MWSEK

NEW

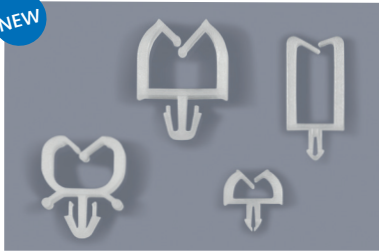

Miniatur-Kabelhalter, steckbar
Miniature plug-in cable holders

MWSET

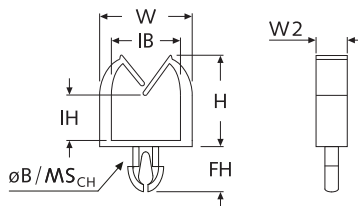

MWS

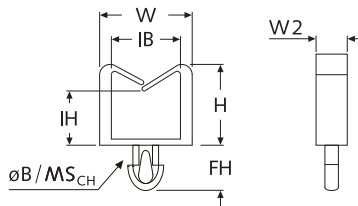

MWSEA

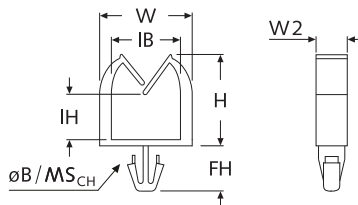

MWSEK

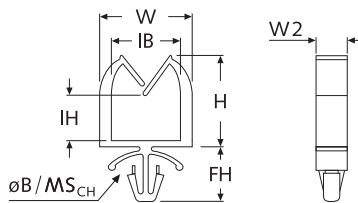

Art.-Nr. natur	Artikel-Bez.	B _{CH} ø	MS _{CH} max	IB x IH	W	W2	FH	H	Farbe
01026	MWSET1-1-01	1,7	1,6	4,8x1,2	7,0	2,0	3,3	4,0	□
01027	MWSET1-2-01	1,7	1,6	4,8x3,0	7,0	2,0	3,3	6,0	□
52482	MWSET1-3-01	1,7	2,4	4,8x1,2	7,0	2,0	4,1	4,0	□
52483	MWSET1-4-01	1,7	2,4	4,8x3,0	7,0	2,0	4,1	6,0	□
00436	MWS-01-01	1,8	1,6	4,5x3,0	6,9	1,9	3,3	5,8	□
52391	MWS-02-01	1,8	1,6	4,5x8,5	6,9	1,9	3,3	11,2	□
52392	MWS-03-01	1,8	2,2	4,5x8,5	6,9	1,9	3,3	11,2	□
52484	MWS-04-01	1,8	2,4	4,5x3,0	6,9	1,9	3,3	5,8	□
40803	MWSEK1-1-01	3,0	0,6-1,6	7,2x3,7	9,7	4,0	5,1	7,1	□
01028	MWSET2-1-01	3,0	1,0-1,2	6,7x3,1	9,1	4,0	4,3	7,3	□
01029	MWSET2-2-01	3,0	1,2-1,6	6,7x3,1	9,1	4,0	4,8	7,3	□
01030	MWSEA10-1-01	3,0	1,6	6,7x3,0	9,1	4,0	4,8	7,3	□
16663	MWSEA10-2-01	3,0	1,6	8,2x3,9	10,8	4,0	4,8	9,1	□
16664	MWSEA10-3-01	3,0	1,6	9,4x6,0	12,0	4,0	4,8	11,2	□
16665	MWSEA10-4-01	3,0	1,6	9,4x7,7	12,0	4,0	4,8	13,0	□
52394	MWSEA11-1-01	3,0	2,4	6,7x3,0	9,1	4,0	4,8	7,3	□
52395	MWSEA11-2-01	3,0	2,4	8,2x3,9	10,8	4,0	4,8	9,1	□
52396	MWSEA11-3-01	3,0	2,4	9,4x6,0	12,0	4,0	4,8	11,2	□
52397	MWSEA11-4-01	3,0	2,4	9,4x7,7	12,0	4,0	4,8	13,0	□
01031	MWSEA20-1-01	3,5	1,6	6,7x3,0	9,1	4,0	4,8	7,3	□
01032	MWSEA20-2-01	3,5	1,6	8,2x3,9	10,8	4,0	4,8	9,1	□
01033	MWSEA20-3-01	3,5	1,6	9,4x6,0	12,0	4,0	4,8	11,2	□
01034	MWSEA20-4-01	3,5	1,6	9,4x7,7	12,0	4,0	4,8	13,0	□
52398	MWSEA21-1-01	3,5	2,4	6,7x3,0	9,1	4,0	4,8	7,3	□
52399	MWSEA21-2-01	3,5	2,4	8,2x3,9	10,8	4,0	4,8	9,1	□
52400	MWSEA21-3-01	3,5	2,4	9,4x6,0	12,0	4,0	4,8	11,2	□
52401	MWSEA21-4-01	3,5	2,4	9,4x7,7	12,0	4,0	4,8	13,0	□

weitere Abmessungen a. A. · Unit: mm · MOQ 100x

Standard-Material: PA UL-94 V-2 □ natur -40°C bis +75°C
Auf Anfrage: PA UL-94 V-0 □ natur -40°C bis +75°C

■ HURC

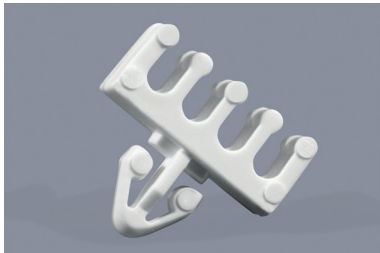

Miniatur-Kabelhalter

Miniature cable holders

$B_{CH} = \varnothing 5,0$	Art.-Nr.	Artikel-Bez.	B_{CH}	MS_{CH}	Farbe
	weiß		\varnothing	max	
$MS_{CH} = 2,0$	01177	HURC-I-4-W	5,0	2,0	<input type="checkbox"/>
	a. A. mit 3 Armen · Unit: mm · MOQ 100x				

Standard-Material:

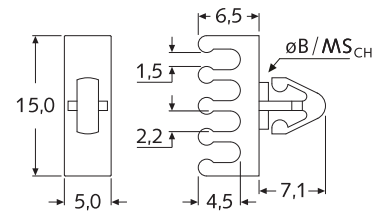
 PA-GV (25%) UL-94 HB weiß
 -40°C bis +110°C

Info: Dieser Litzenhalter kann bis zu 12 Litzen, mit mind. 1,5 mm bis max. 2,2 mm Durchmesser gleichzeitig aufnehmen.

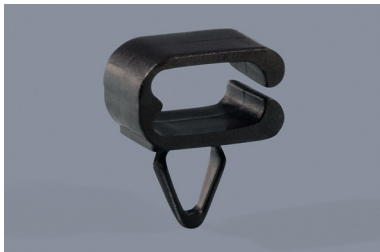
■ WS-MI



Miniatur-Kabelhalter, steckbar

Miniature plug-in cable holders

$B_{CH} = \varnothing 5,0$	Art.-Nr.	Artikel-Bez.	B_{CH}	MS_{CH}	Farbe
	schwarz		\varnothing	max	
$MS_{CH} = 1,6$	03406	WS-MI-S	5,0	1,6	<input checked="" type="checkbox"/>
	37912	WS-MI-W	5,0	1,6	<input type="checkbox"/>
	Unit: mm · MOQ 100x				

Standard-Material:

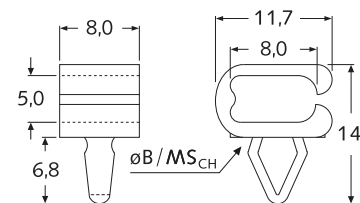
 POM UL-94 HB schwarz / weiß
 -40°C bis +95°C

Info: Dieser Litzenhalter kann mehrere Litzen aufnehmen.
 Die Kabel sind durch die seitliche Öffnung wiederlösbar.

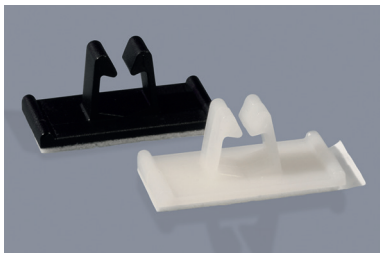
■ RKAW



Rundkabelhalter, selbstklebend

Self-adhesive round cable holders

Art.-Nr.	Artikel-Bez.	L	W	W2	H	Farbe
26735	RKAW-064-MN-A	17,8	8,9	5,6	11,8	<input type="checkbox"/>
26736	RKAW-064-MS-A	17,8	8,9	5,6	11,8	<input checked="" type="checkbox"/>
00802	RKAW-064-XN-A	25,5	12,6	5,7	11,6	<input type="checkbox"/>
26737	RKAW-064-XS-A	25,5	12,6	5,7	11,6	<input checked="" type="checkbox"/>

weitere Abmessungen a. A. · Unit: mm · MOQ 100/1.000x

Standard-Material: PA UL-94 V-2 natur -40°C bis +75°C
 PA UL-94 V-2 schwarz -40°C bis +75°C

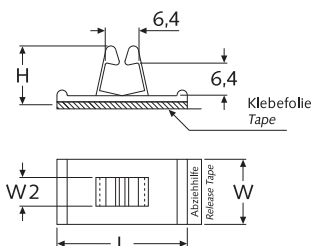
Info: Klebefolie: Acrylat (3M), Dauergebrauchstemperatur -30°C bis +75°C

MWSB + MWSEB



Miniatur-Kabelhalter, selbstklebend

Self-adhesive miniature cable holders

Art.-Nr.	Artikel-Bez.	IB x IH	L	W	W2	S	H	Farbe
00437	MWSB-01-01A-RT	4,3 x 3,0	9,5	7,0	2,0	1,4	4,8	☐
01739	MWSEB-1-01A-RT	4,8 x 1,3	9,5	7,0	2,0	1,6	4,0	☐
03568	MWSEB-2-01A-RT	4,8 x 3,3	9,5	7,0	2,0	1,6	6,0	☐
07325	MWSEB-3-01A-RT	6,6 x 3,0	12,7	9,0	4,0	2,0	7,3	☐
03449	MWSEB-4-01A-RT	8,0 x 4,8	12,7	10,8	4,0	2,0	9,2	☐
07326	MWSEB-5-01A-RT	9,1 x 5,8	12,7	11,9	4,0	2,0	11,2	☐
07327	MWSEB-6-01A-RT	9,1 x 8,4	12,7	11,9	4,0	2,0	13,0	☐

weitere Abmessungen a. A. · Unit: mm · MOQ 100x

Standard-Material: PA UL-94 V-2 ☐ natur -40°C bis +75°C

Auf Anfrage: PA UL-94 V-0 ☐ natur -40°C bis +75°C

Info: Klebefolie: Acrylat, Dauergebrauchstemperatur -30°C bis +60°C

MWSB

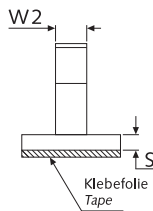
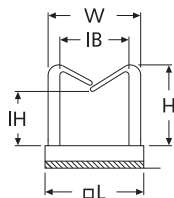

MWSEB

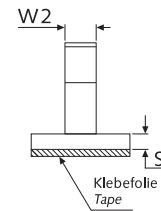
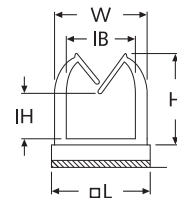

WCK

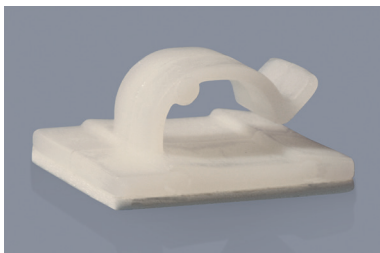

Rundkabelhalter, selbstklebend

Self-adhesive round cable holders

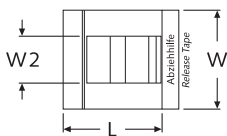
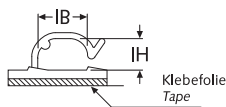

Art.-Nr.	Artikel-Bez.	IB x IH	L	W	W2	KT	Ausführung	Farbe
02623	WCK-180-01A-RT	4,1 x 4,6	16,0	15,7	7,9	A	AH	☐
03988	WCK-180-01-E-3M-A	5,0 x 4,9	19,0	19,0	10,0	A	OH	☐
12608	WCK-180-01-E-3MV-A	5,0 x 6,0	19,0	19,0	10,0	C	OH	☐
03415	WCK-460-01-P-A	7,0 x 11,7	25,4	25,4	12,4	B	ST	☐
02630	WCK-460-01A-RT	7,1 x 11,4	25,1	25,1	11,9	A	AH	☐
08819	WCK-420-01-P-A	8,0 x 11,7	19,0	19,0	9,5	A	ST	☐
03989	WCK-460-01-E-3M-A	8,0 x 12,0	26,0	26,0	12,5	A	OH	☐
12607	WCK-460-01-E-3MV-A	8,0 x 12,0	26,0	26,0	12,5	C	OH	☐
02631	WCK-720-01A-RT	13,5 x 18,3	25,4	25,4	12,7	A	AH	☐
03990	WCK-720-01-E-3M-A	15,0 x 18,0	26,0	26,0	16,0	A	OH	☐

weitere Abmessungen a. A. · Unit: mm · MOQ 100x

Standard-Material: PA UL-94 V-2 ☐ natur -40°C bis +75°C

KT = Klebefolien-Temperaturbereich: A: -30°C bis +60°C - kurzzeitig: +75°C

B: -20°C bis +90°C - kurzzeitig: +150°C

C: -30°C bis +110°C - kurzzeitig: +190°C

Ausführungen: AH = mit Abziehhilfe, OH = ohne Abziehhilfe, ST = auf Streifen zu 10 Stück

MWSSEB + MWSSEBE

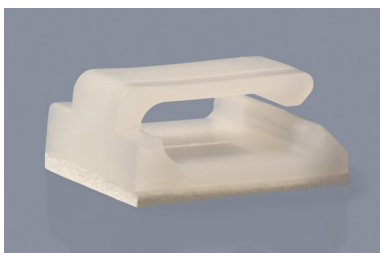

Miniatur-Kabelhalter, selbstklebend

Self-adhesive miniature cable holders

Art.-Nr.	Artikel-Bez.	L	Farbe
00438	MWSSEB-01-01A-RT natur	9,5	☐
00439	MWSSEBE-01-01A-RT natur	12,7	☐
NEW 46932	MWSSEBE-01-01A-RT sw	12,7	■

Unit: mm · MOQ 100x

Standard-Material:

PA UL-94 V-2 ☐ natur / ■ schwarz

-40°C bis +75°C

Info: Klebefolie: Acrylat, Dauergebrauchstemperatur -30°C bis +60°C

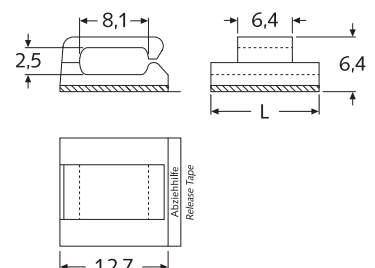

RKS



Rundkabelhalter, steckbar

Plug-in round cable holders

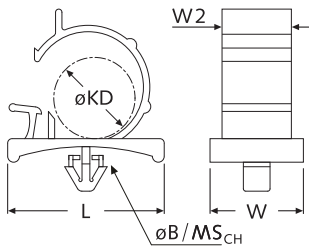

Art.-Nr.	Artikel-Bez.	KD ø	B _{CH} ø	MS _{CH}	L	W	W2	Höhe	Farbe
05529	RKS-064/20-G	6,4	6,4	2,0-3,8	25,4	14,7	10,4	11,2	■
05534	RKS-095/38-G	9,5	6,4	2,0-3,8	25,4	16,5	12,7	12,7	■
39650	RKS-095/27-N	9,5	6,5-7,0	0,6-2,7	23,9	14,4	14,4	15,0	□
16657	RKS-105/16-N	10,5	6,5	0,8-1,6	25,7	16,8	11,8	15,0	□
39649	RKS-127/27-N	12,7	5,0-6,0	0,6-2,7	31,8	19,0	16,0	18,4	□
03493	RKS-190/20-G	19,0	6,4	0,5-2,0	35,1	22,4	17,1	24,6	■
39651*	RKS-250/16-N*	25,0	6,5	0,8-1,6	38,7	9,5	9,5	30,0	□
39652*1	RKS-300/20-N*1	30,0	6,5	0,8-2,0	43,0	9,5	9,5	36,0	□

*Bauform ähnlich zu Skizze · 1abweichende Brandklasse UL-94 V-0 · Unit: mm · MOQ 100x

Standard-Material: PA UL-94 V-2 □ natur -40°C bis +75°C
PA UL-94 V-2 ■ hellgrau (G) -40°C bis +75°C

RKSV



Rundkabelhalter, steckbar

Plug-in round cable holders

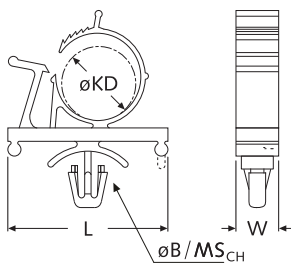

Art.-Nr.	Artikel-Bez.	KD ø	B _{CH} ø	MS _{CH}	L	W	Höhe	Farbe
26490*	RKSV-070095/16-N	7,0-9,5	6,4*	0,8-1,6	22,0	12,2	24,1	□
42824	RKSV-079102/15-N	7,9-10,2	6,4	0,8-1,5	19,1	8,2	21,5	□
26491	RKSV-119143/15-N	11,9-14,3	6,4	0,8-1,5	31,5	10,2	29,8	□
00981	RKSV-147191/15-N	14,7-19,1	6,4	0,8-1,5	38,1	12,7	34,5	□

*siehe Montagebohrung für Artikel: 26490 · Unit: mm · MOQ 100x

Standard-Material: PA UL-94 V-2 □ natur -40°C bis +75°C
Material auf Anfrage: PA UL-94 V-0 □ natur -40°C bis +75°C

Montagebohrung für Artikel: 26490
Mounting Hole for item: 26490

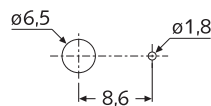

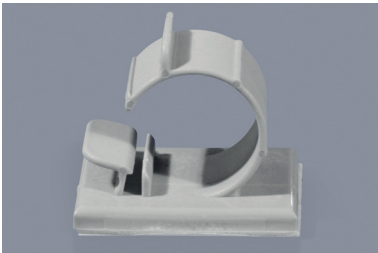
RKA

Rundkabelhalter, selbstklebend

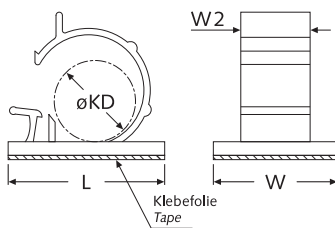
Self-adhesive round cable holders

RKAS

NEW

Rundkabelhalter, selbstklebend

Self-adhesive round cable holders

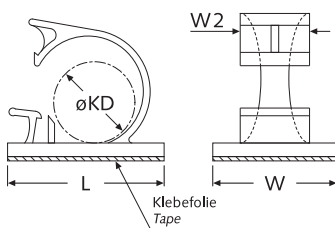
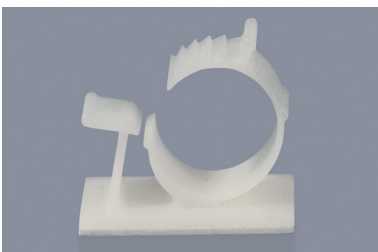
RKAV

Rundkabelhalter, selbstklebend

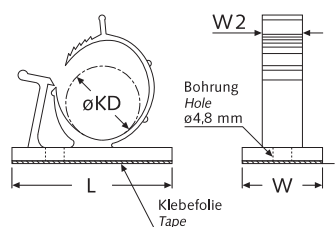
Self-adhesive round cable holders



Art.-Nr.	Artikel-Bez.	KD ø	L	W	W2	Farbe
11335	RKA-048-G-A grau	5,0	16,0	18,8	9,7	■
34545	RKA-064-G-A grau	6,4	22,1	25,4	16,0	■
11337	RKA-095-G-A grau	9,5	25,4	25,4	12,7	■
26731	RKA-104-N-A natur	10,4	21,6	17,0	12,0	□
03496	RKA-110-G-A grau	11,0	25,3	25,4	16,1	■
34546	RKA-127-G-A grau	12,7	30,7	25,4	16,3	■
03497	RKA-191-G-A grau	19,6	37,0	29,3	16,9	■
11338	RKA-254-G-A grau	26,8	57,1	50,5	31,7	■

weitere Abmessungen a. A. · Unit: mm · MOQ 100x

Standard-Material: PA UL-94 V-2 ■ grau (G) -40°C bis +75°C
 PA UL-94 V-2 □ natur (N) -40°C bis +75°C

Info: Klebefolie: Acrylat (3M), Dauergebrauchstemperatur -30°C bis +75°C

Art.-Nr.	Artikel-Bez.	KD ø	L	W	W2	Höhe ca.	Farbe
30631	RKAS-040-N-A	4,0	13,0	10,0	6,8	9,0	□
30632	RKAS-060-N-A	6,0	15,0	13,0	9,0	11,0	□
30633	RKAS-090-N-A	9,0	21,6	19,0	12,8	14,0	□
30634	RKAS-110-N-A	11,0	25,0	20,0	13,2	16,0	□
30635	RKAS-134-N-A	13,4	32,0	25,4	16,0	18,4	□
30636	RKAS-180-N-A	18,0	35,8	24,8	16,8	23,0	□
30637	RKAS-254-N-A	25,4	56,1	50,0	20,1	30,5	□
30638	RKAS-300-N-A	30,0	56,1	50,0	20,1	35,0	□

*ohne Bohrung und Abziehhilfe · †ohne Bohrung · Unit: mm · MOQ 50/100x

Standard-Material: PA UL-94 V-2 □ natur -40°C bis +75°C

Info: Klebefolie: Acrylat, Dauergebrauchstemperatur -30°C bis +75°C

Art.-Nr.	Artikel-Bez.	KD ø	L	W	W2	Höhe	Farbe
26732	RKAV-055/065-A-RT	5,5-6,5	21,6	16,5	10,0	18,0	□
01068	RKAV-079/103-A-RT	7,9-10,3	25,4	19,1	10,2	22,0	□
26733*	RKAV-110/133-A	11,0-13,3	25,4	15,0	10,0	24,8	□
01067	RKAV-119/143-A-RT	11,9-14,3	31,5	19,1	10,0	27,7	□
01069	RKAV-147/191-A-RT	14,7-19,1	38,1	19,1	12,7	32,8	□
26734*	RKAV-180/220-A	18,0-22,0	36,0	19,0	12,7	35,5	□
01070	RKAV-220/265-A-RT	22,2-25,4	50,5	25,4	12,7	44,5	□
27081 ¹	RKAV-254/371-A-RT	25,4-31,7	63,5	25,4	12,7	50,8	□

*ohne Bohrung und Abziehhilfe · †ohne Bohrung · Unit: mm · MOQ 100x

Standard-Material: PA UL-94 V-2 □ natur -40°C bis +75°C

Info: Klebefolie: Acrylat, Dauergebrauchstemperatur -30°C bis +60°C

FKSB

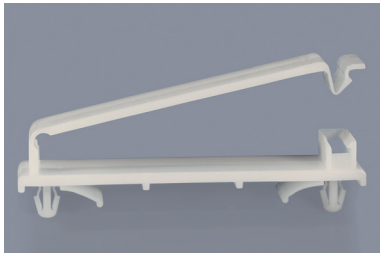

Flachband-Kabelhalter, steckbar
Plug-in flat cable holders

$B_{CH} = \varnothing 4,8$	Art.-Nr.	Artikel-Bez.	H	B_{CH} \varnothing	MS_{CH}	Farbe
	natur					
$MS_{CH} = 0,8-2$	26493	FKSB-645/09	9,0	4,8	0,8-2	□
	26494	FKSB-645/16	15,5	4,8	0,8-2	□

Unit: mm · MOQ 100x

Standard-Material:

PA UL-94 V-2 □ natur
-40°C bis +75°C

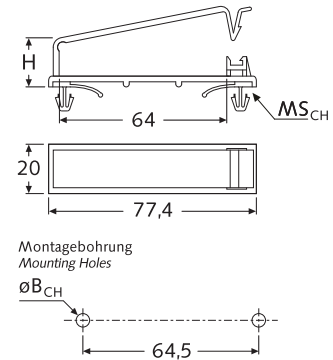

FKS

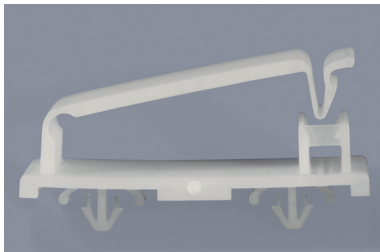

Flachband-Kabelhalter, steckbar
Plug-in flat cable holders

Art.-Nr.	Artikel-Bez.	Litzen* (Anzahl)	B_{CH} \varnothing	MS_{CH}	IB	L	W	H	BA	Typ	Farbe
26495	FKS-15/12-N	15	4,0	0,8-1,2	24,2	36,4	8,0	12,3	20,0	B	□
26496	FKS-20/12-N	20	4,0	0,8-2,2	32,0	45,5	19,0	12,0	25,0	B	□
26497	FKS-25/12-N	25	4,0	0,8-2,2	40,0	53,5	19,0	11,7	30,0	B	□
43311	FKS-25/12-S	25	4,0	0,8-2,2	40,0	53,5	19,0	11,7	30,0	B	■
26498	FKS-35/19-N	35	4,0	0,8-2,0	52,0	65,0	10,0	19,1	30,0	B	□
14561	FKS-40/16-N	40	4,0	1,0-2,0	54,0	67,5	10,0	16,4	40,0	A	□
43312	FKS-40/16-S	40	4,0	1,0-2,0	54,0	67,5	10,0	16,4	40,0	A	■
26499	FKS-50/19-S	50	4,8	0,8-3,2	64,2	77,7	19,7	18,6	40,0	B	■

*die Angaben der max. Litzenanzahl sind Richtwerte · Unit: mm · MOQ 100x

Typ A

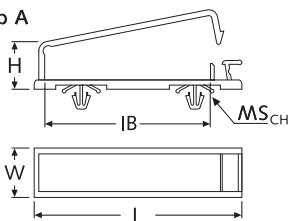

Typ B

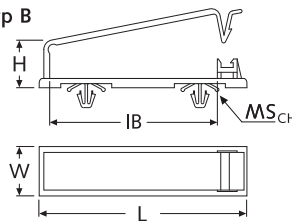

Standard-Material:

PA UL-94 V-2 □ natur / ■ schwarz
-40°C bis +75°C

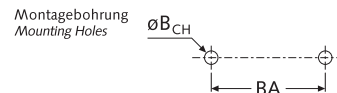

FKSN / FKSNC

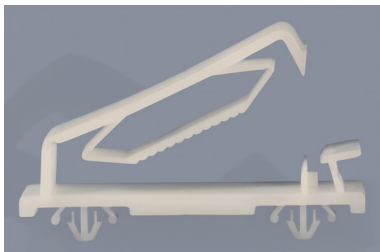

Flachband-Kabelhalter, steckbar
Plug-in flat cable holders

Art.-Nr.	Artikel-Bez.	Litzen* (Anzahl)	B_{CH} \varnothing	MS_{CH}	IB	L	W	H	BA	Farbe
25590	FKSN-10/09	10	4,0	1,0-2,0	14,5	32,5	9,1	13,7	15,0	□
NEW 54187	FKSNC-15/05	15	3,0	0,8-1,6	21,0	28,0	8,0	8,0	19,6	■
14562	FKSN-20/13	20	4,0	1,0-2,0	25,0	39,6	13,2	13,0	20,0	□
26492	FKSN-30/13	30	4,0	0,8-2,2	39,6	55,0	12,5	12,6	35,0	□
14563	FKSN-40/10	40	4,0	0,8-2,2	53,8	65,0	10,2	11,6	40,0	□
14564	FKSN-50/10	50	4,0	0,8-2,2	64,3	77,0	10,0	12,3	49,7	□

*die Angaben der max. Litzenanzahl sind Richtwerte · Unit: mm · MOQ 100x

Standard-Material: PA UL-94 V-2 □ natur / ■ schwarz -40°C bis +75°C

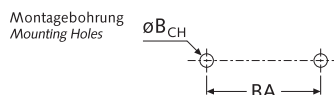
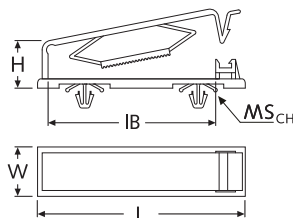

FKSNB

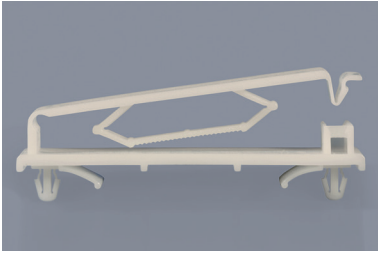

Flachband-Kabelhalter, steckbar
Plug-in flat cable holders

$B_{CH} = \varnothing 4,8$	Art.-Nr. natur	Artikel-Bez. FKSNB-640/16	B_{CH} \varnothing	MS_{CH} 0,8-2,2	Farbe <input type="checkbox"/>
Unit: mm · MOQ 100x					

Standard-Material:
PA UL-94 V-2 natur
-40°C bis +75°C

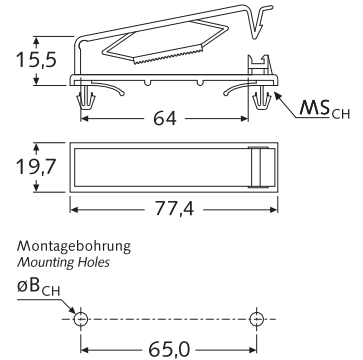

FKA



Flachband-Kabelhalter, selbstklebend
Self-adhesive flat cable holders

Art.-Nr. natur	Artikel-Bez.	Litzen* (Anzahl)	IB	L	W	H	Typ	Farbe <input type="checkbox"/>
42822	FKA-10/04-A	10	16,0	20,6	10,0	3,9	B	<input type="checkbox"/>
46499	FKA-15/07-A	15	19,0	28,0	10,0	7,0	A	<input type="checkbox"/>
26501	FKA-20/09-A	20	31,5	40,7	12,7	7,5	A	<input type="checkbox"/>
14569	FKA-25/11-A	25	32,0	45,8	19,0	11,2	A	<input type="checkbox"/>
26502	FKA-25/18-A	25	32,0	45,8	19,8	18,0	A	<input type="checkbox"/>
14570	FKA-30/11-A	30	40,0	53,5	19,3	11,2	A	<input type="checkbox"/>
26503	FKA-30/15-A	30	40,0	53,5	19,3	14,8	A	<input type="checkbox"/>
14571	FKA-50/13-A	50	64,0	77,6	19,7	12,8	A	<input type="checkbox"/>
14572	FKA-50/19-A	50	64,5	78,2	18,9	19,0	A	<input type="checkbox"/>

*die Angaben der max. Litzenanzahl sind Richtwerte · Unit: mm · MOQ 100x

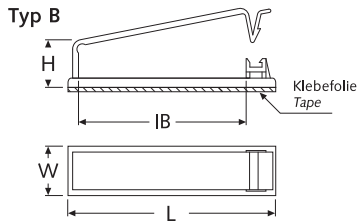
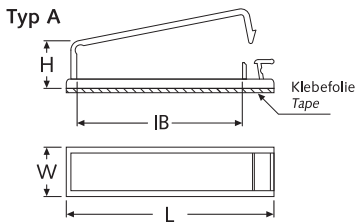

Standard-Material:
PA UL-94 V-2 natur
-40°C bis +75°C

Info: Klebefolie: Acrylat (3M)
Dauerterperatur -30°C bis +75°C

FKAN

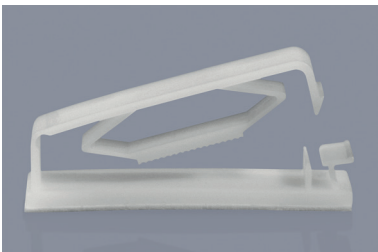

Flachband-Kabelhalter, selbstklebend
Self-adhesive flat cable holders

Art.-Nr. natur	Artikel-Bez.	Litzen* (Anzahl)	IB	L	W	H	Typ	Farbe <input type="checkbox"/>
14565	FKAN-25/16	25	32,5	46,8	18,9	15,2	B	<input type="checkbox"/>
14566	FKAN-40/16	40	54,0	67,0	16,0	15,6	A	<input type="checkbox"/>
17912	FKAN-50/12	50	64,0	78,0	19,7	12,4	B	<input type="checkbox"/>

*die Angaben der max. Litzenanzahl sind Richtwerte · Unit: mm · MOQ 100x

Standard-Material: PA UL-94 V-2 natur -40°C bis +75°C

Info: Klebefolie: Acrylat (3M), Dauergebrauchstemperatur -30°C bis +75°C

