

FKSB

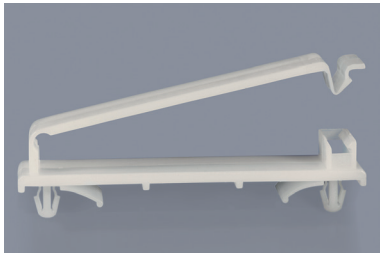

Flachband-Kabelhalter, steckbar  
Plug-in flat cable holders

$B_{CH} = \varnothing 4,8$	Art.-Nr.	Artikel-Bez.	H	$B_{CH}$ $\varnothing$	$MS_{CH}$	Farbe
	natur					
$MS_{CH} = 0,8-2$	26493	FKSB-645/09	9,0	4,8	0,8-2	□
	26494	FKSB-645/16	15,5	4,8	0,8-2	□

Unit: mm · MOQ 100x

Standard-Material:

PA UL-94 V-2 □ natur  
-40°C bis +75°C

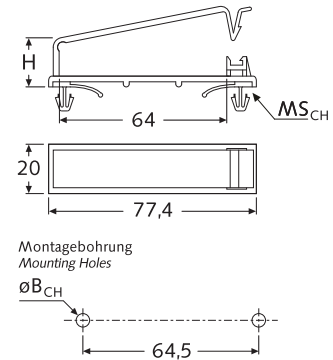

FKS

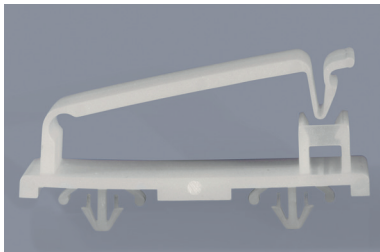

Flachband-Kabelhalter, steckbar  
Plug-in flat cable holders

Art.-Nr.	Artikel-Bez.	Litzen* (Anzahl)	$B_{CH}$ $\varnothing$	$MS_{CH}$	IB	L	W	H	BA	Typ	Farbe
26495	FKS-15/12-N	15	4,0	0,8-1,2	24,2	36,4	8,0	12,3	20,0	B	□
26496	FKS-20/12-N	20	4,0	0,8-2,2	32,0	45,5	19,0	12,0	25,0	B	□
26497	FKS-25/12-N	25	4,0	0,8-2,2	40,0	53,5	19,0	11,7	30,0	B	□
43311	FKS-25/12-S	25	4,0	0,8-2,2	40,0	53,5	19,0	11,7	30,0	B	■
26498	FKS-35/19-N	35	4,0	0,8-2,0	52,0	65,0	10,0	19,1	30,0	B	□
14561	FKS-40/16-N	40	4,0	1,0-2,0	54,0	67,5	10,0	16,4	40,0	A	□
43312	FKS-40/16-S	40	4,0	1,0-2,0	54,0	67,5	10,0	16,4	40,0	A	■
26499	FKS-50/19-S	50	4,8	0,8-3,2	64,2	77,7	19,7	18,6	40,0	B	■

\*die Angaben der max. Litzenanzahl sind Richtwerte · Unit: mm · MOQ 100x

Typ A

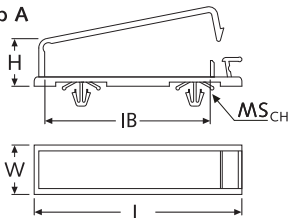

Typ B

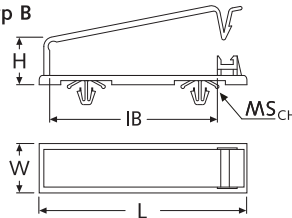

Standard-Material:

PA UL-94 V-2 □ natur / ■ schwarz  
-40°C bis +75°C

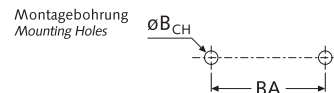

FKSN / FKSNC

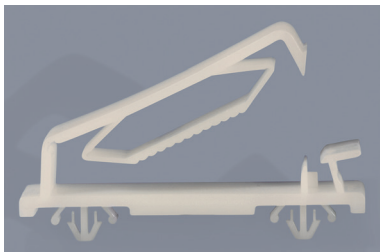

Flachband-Kabelhalter, steckbar  
Plug-in flat cable holders

Art.-Nr.	Artikel-Bez.	Litzen* (Anzahl)	$B_{CH}$ $\varnothing$	$MS_{CH}$	IB	L	W	H	BA	Farbe
25590	FKSN-10/09	10	4,0	1,0-2,0	14,5	32,5	9,1	13,7	15,0	□
<b>NEW</b> 54187	FKSNC-15/05	15	3,0	0,8-1,6	21,0	28,0	8,0	8,0	19,6	■
14562	FKSN-20/13	20	4,0	1,0-2,0	25,0	39,6	13,2	13,0	20,0	□
26492	FKSN-30/13	30	4,0	0,8-2,2	39,6	55,0	12,5	12,6	35,0	□
14563	FKSN-40/10	40	4,0	0,8-2,2	53,8	65,0	10,2	11,6	40,0	□
14564	FKSN-50/10	50	4,0	0,8-2,2	64,3	77,0	10,0	12,3	49,7	□

\*die Angaben der max. Litzenanzahl sind Richtwerte · Unit: mm · MOQ 100x

Standard-Material: PA UL-94 V-2 □ natur / ■ schwarz -40°C bis +75°C

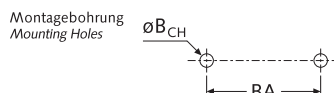
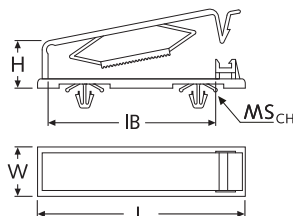

FKSNB

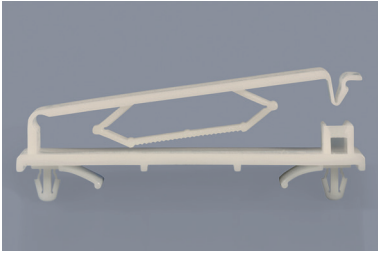

Flachband-Kabelhalter, steckbar  
Plug-in flat cable holders

$B_{CH} = \varnothing 4,8$	Art.-Nr. natur	Artikel-Bez. FKSNB-640/16	$B_{CH}$ $\varnothing$	$MS_{CH}$ 0,8-2,2	Farbe <input type="checkbox"/>
Unit: mm · MOQ 100x					

**Standard-Material:**

PA UL-94 V-2  natur  
-40°C bis +75°C

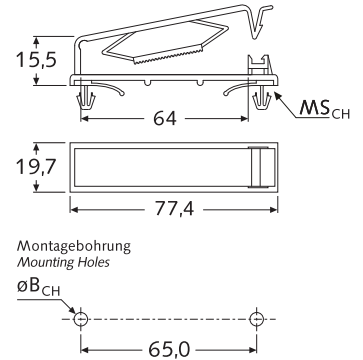

FKA



Flachband-Kabelhalter, selbstklebend  
Self-adhesive flat cable holders

Art.-Nr. natur	Artikel-Bez.	Litzen* (Anzahl)	IB	L	W	H	Typ	Farbe <input type="checkbox"/>
42822	FKA-10/04-A	10	16,0	20,6	10,0	3,9	B	<input type="checkbox"/>
46499	FKA-15/07-A	15	19,0	28,0	10,0	7,0	A	<input type="checkbox"/>
26501	FKA-20/09-A	20	31,5	40,7	12,7	7,5	A	<input type="checkbox"/>
14569	FKA-25/11-A	25	32,0	45,8	19,0	11,2	A	<input type="checkbox"/>
26502	FKA-25/18-A	25	32,0	45,8	19,8	18,0	A	<input type="checkbox"/>
14570	FKA-30/11-A	30	40,0	53,5	19,3	11,2	A	<input type="checkbox"/>
26503	FKA-30/15-A	30	40,0	53,5	19,3	14,8	A	<input type="checkbox"/>
14571	FKA-50/13-A	50	64,0	77,6	19,7	12,8	A	<input type="checkbox"/>
14572	FKA-50/19-A	50	64,5	78,2	18,9	19,0	A	<input type="checkbox"/>

\*die Angaben der max. Litzenanzahl sind Richtwerte · Unit: mm · MOQ 100x

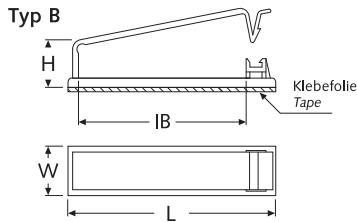
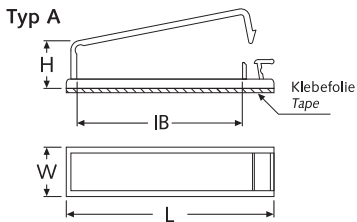

**Standard-Material:**

PA UL-94 V-2  natur  
-40°C bis +75°C

Info: Klebefolie: Acrylat (3M)  
Dauerterperatur -30°C bis +75°C

FKAN

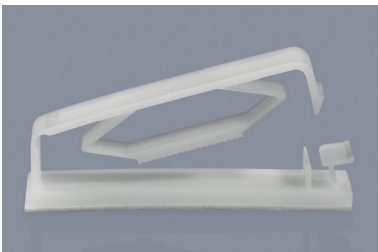

Flachband-Kabelhalter, selbstklebend  
Self-adhesive flat cable holders

Art.-Nr. natur	Artikel-Bez.	Litzen* (Anzahl)	IB	L	W	H	Typ	Farbe <input type="checkbox"/>
14565	FKAN-25/16	25	32,5	46,8	18,9	15,2	B	<input type="checkbox"/>
14566	FKAN-40/16	40	54,0	67,0	16,0	15,6	A	<input type="checkbox"/>
17912	FKAN-50/12	50	64,0	78,0	19,7	12,4	B	<input type="checkbox"/>

\*die Angaben der max. Litzenanzahl sind Richtwerte · Unit: mm · MOQ 100x

**Standard-Material:** PA UL-94 V-2  natur -40°C bis +75°C

Info: Klebefolie: Acrylat (3M), Dauergebrauchstemperatur -30°C bis +75°C

